

WR-1

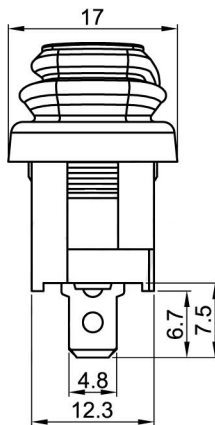

Rating: 12A 125V AC(UL CUL) ;  
 10A 250V AC(ENEC CQC) ;  
 Degree of protection:IP67;  
 Contact Resistance: 50mΩ Max. ;  
 Insulation Resistance:DC 500V 100MΩ Min. ;  
 Dielectric Strength:AC 1500V 1 minute  
 Operating Force:600± 150gf  
 Mechanical Life:50,000 cycles  
 Load Life:10,000 cycles  
 Operating Temperature: 0°C~85°C

CUT-OUT

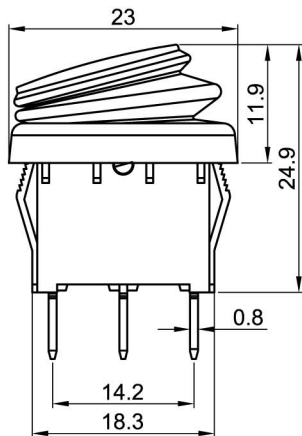
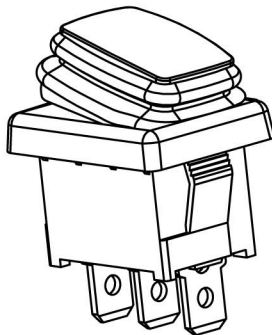
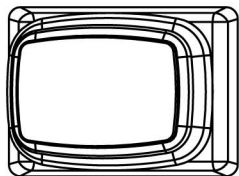
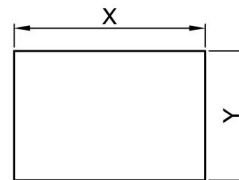

	X	Y
0.75~1.25	19.2-0.1	13.0+0.1
1.25~2.00	19.4-0.1	13.0+0.1
2.00~3.00	19.8-0.1	13.0+0.1

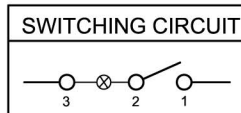

WR1-110-PXL-BR-220

01.086.0129

**MATERIAL:**

Body:Nylon66,UL rated:94V-2 min.

Actuator:PC.

Terminal:Brass,silver or tin plated.